



Regional & Branch Offices:

EAST

BHUBANESWAR : A-167, Unit No. 102, First Floor, The Metropolis, Near Sparsh Hospital, Saheed Nagar, Bhubaneswar - 751007, Odisha. Tel. 0674 2549960

GUWAHATI : 3rd Floor, Purbi Complex, Near Panbazar Flyover, A. T. Road, Guwahati - 781001.

KOLKATA : Unit No-1108, 11th Floor, Godrej Genesis, Plot-XI, Block EP & GP Salt Lake, Sector - V, Kolkata - 700091.

PATNA : L-302, 303 Dumraon Palace, 3rd Floor, Fraser Road, Near Dakbangla Crossing, Patna - 800001.

RANCHI : 2A- 2nd Floor, Poornima Tower, Opp. Chaganlal Jain Dharmshala, Lake Road, Ranchi, Jharkhand - 834001

NORTH

MOHALI : Unit No.B-424, Bestech Business Towers, Sector 66, Mohali, Punjab - 160055. Tel. 9811588257

NOIDA : B9, 1st Floor Sector - 3, Near Bajaj Bhawan, Noida - 201301. Tel. 0120 4848550

DEHRADUN : 57 GDG Tower Adjoining Hotel Calista Patel Nagar Dehradun, Uttarakhand - 248001, Tel. 0135 2728758

Corporate Office:

POLYCAB INDIA LIMITED

Polycab House, 771, Mogul Lane, Mahim (W), Mumbai - 400 016, Maharashtra (India)

Ph.: +91-22-2432 7070/4, 6735 1400, Email: enquiry@polycab.com, Toll Free No.: 1800 267 0008

WEST

AHMEDABAD : 102-1st Floor, Hrishikesh, Nr. IDBI Bank Cross Road, Gulbai Tekra, Ahmedabad - 380006. Tel. 079 26301655

INDORE : B-12, New Siyaganj, Patthar Godam Road, Indore - 452003. Tel. 0731 4033357

PUNE : Off No. 36, Sangam Project Phase 2, Near RTO Pune, Near Sangam Bridge, Pune - 411001. Tel. 020 26058277

RAIPUR : 506, 5th Floor, Wallfort Ozone, Near Fafadih Chowk, Raipur - 492001. Tel. 0771 2582925, 4221686

NAGPUR : Shree Ganesh Enclave, Plot No. 12, 1st Floor, Near ST Stand, Ganeshpeth, Nagpur - 440018

SOUTH

KOCHI : 34/138 C, NH By-Pass Road, Edappally, Kochi - 682024. Tel. 0484 2803285

BENGALURU : B-78, No.18, 4th Main Road, KSSIDC Industrial Estate, 6th Block, Rajajinagar, Bangalore - 560010. Tel. 080 23102172 / 8354

CHENNAI : Gee Gee Universal, 8th Floor, No.2, Mc Nichols Road, 3rd Lane, Near Metha Hospital Chetpet, Chennai - 600 031, Phone. 044-42817272

SECUNDERABAD : 208-209, 2nd Floor Bhuvana Towers S. D. Road, Secunderabad - 500 003. Tel. 040 66326228



SWITCH TO A NEW LEVEL OF SOPHISTICATION

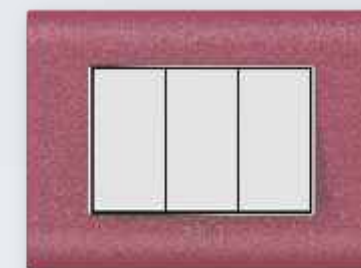

Pricelist - w.e.f 1st January 2021

EWA / JANUARY / 2021

www.polycab.com

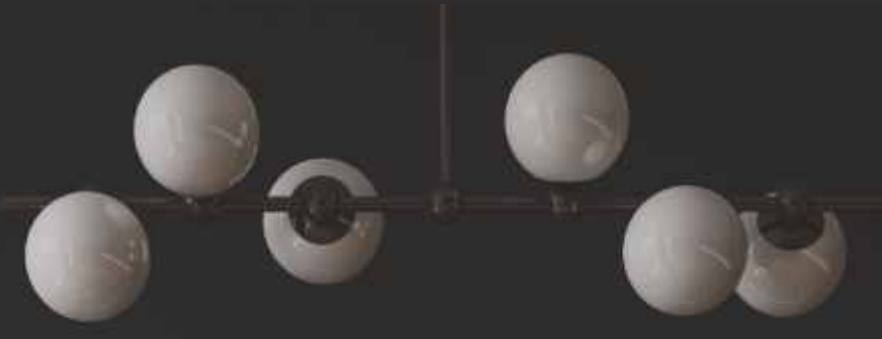

SWITCH TO QUALITY & CLASS

Enhance your living spaces with luxury switches from Polycab. Check out the intricately crafted masterpieces that are ready to embellish your walls and enthrall every visitor. Even the technology is spellbinding as it offers you switches with USB sockets, LED lights, feather touch and much more. Give your walls the luxury they deserve.



5 PART MECHANISM



High Grade PC Rocker



No melting of Plunger, No breakdown



Engineered Arc Shield



Anti-wield Technology with Bimetallic Silver Tip



High Heat Resistance Polycarbonate Housing



Soft Touch Control



Minimal Sound of Operation



Zero Spark Switch



Salient Features:

- Double rocker Mechanism-
Soundless soft touch
- FR Polycarbonate,
- Bimetal contacts with Silver Tip
- Also available with touch
and remote

 POLYCAB

LEVANA

Curl
SERIES

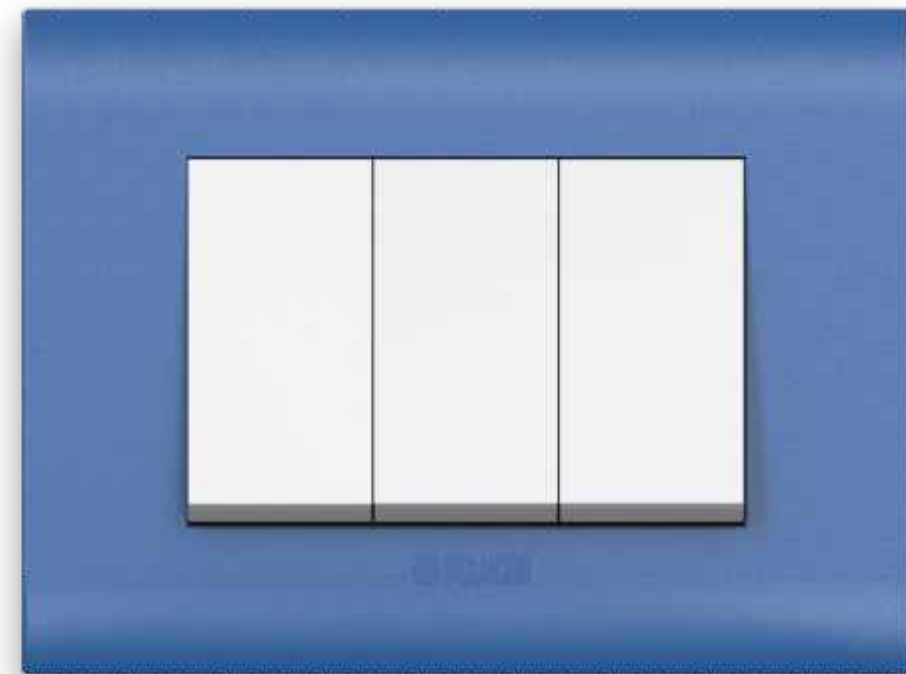

BLUE

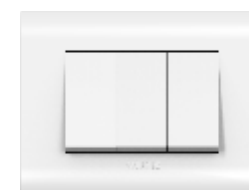

WHITE

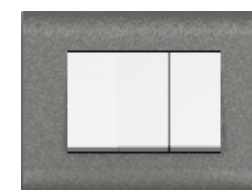

MAGNESIUM GREY



BLUE



PINK



Salient Features:

- Double rocker Mechanism-
Soundless soft touch
- FR Polycarbonate,
- Bimetal contacts with Silver Tip
- Also available with touch
and remote

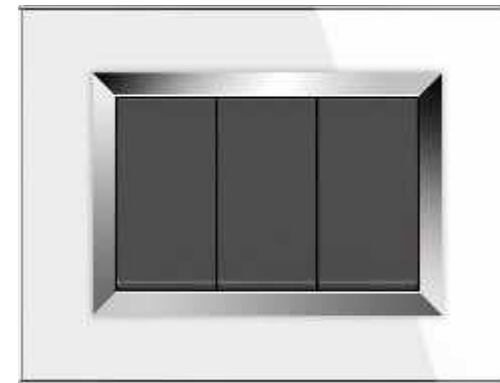

WHITE



BLACK

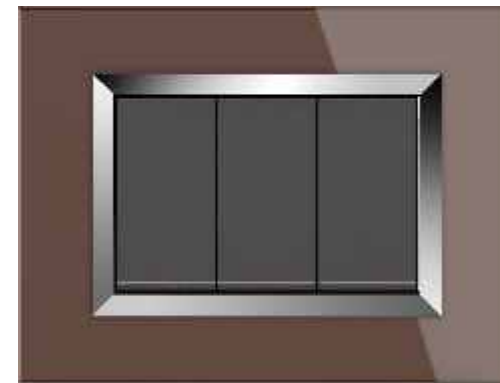

CHOCOLATE

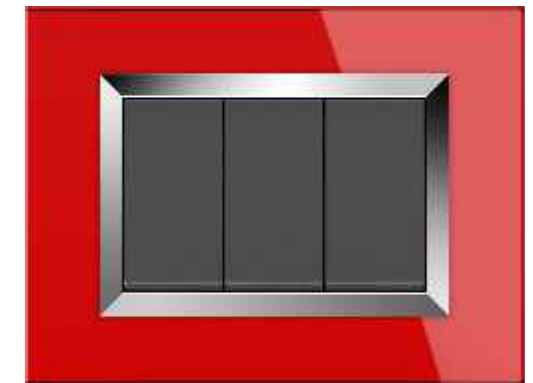

RED



FROSTED MIRROR

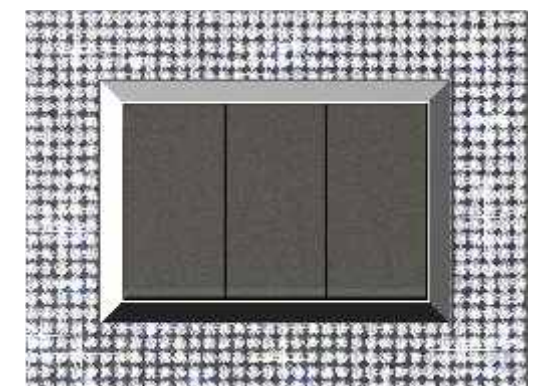

CRYSTAL

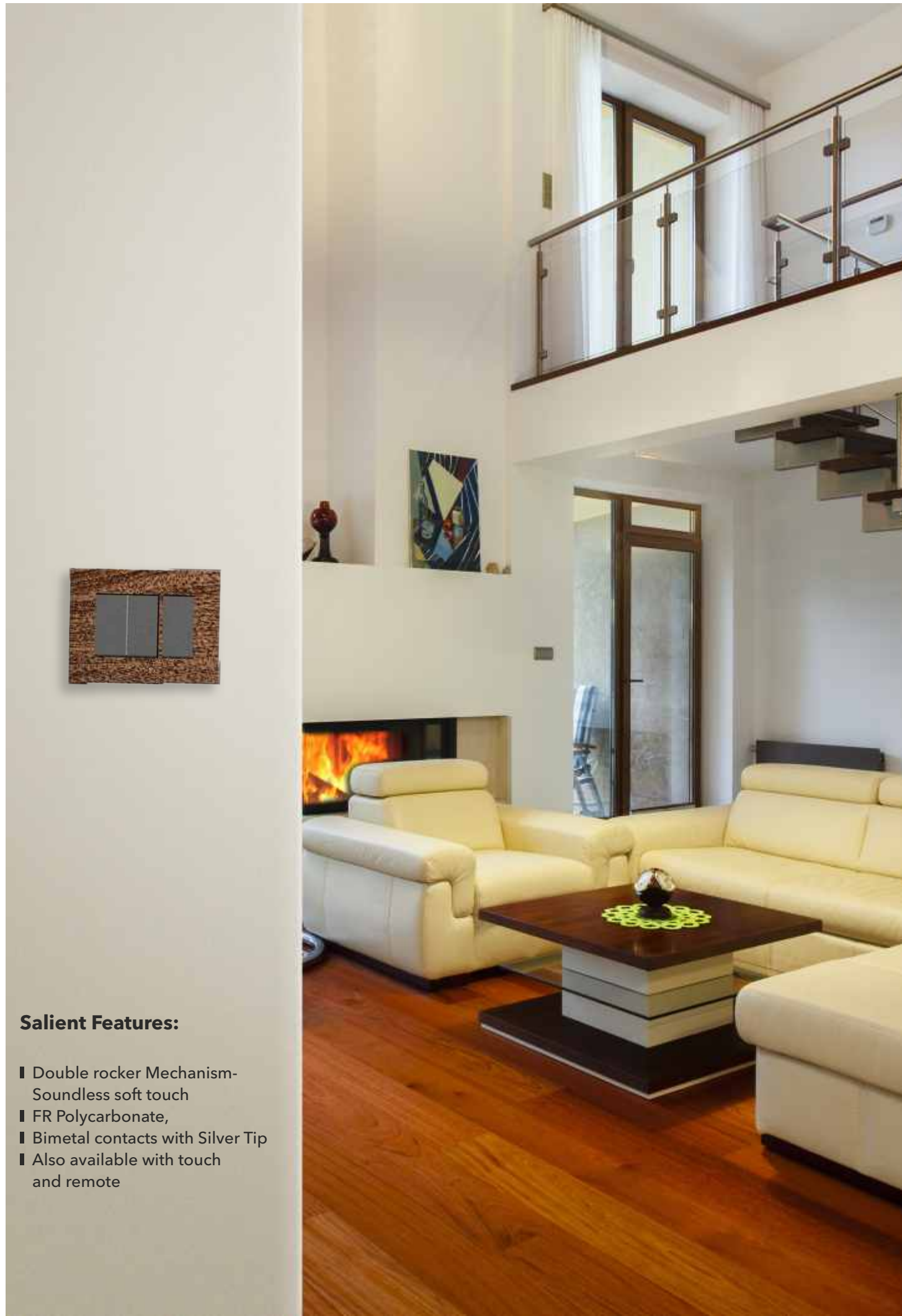

Salient Features:

- Double rocker Mechanism-
Soundless soft touch
- FR Polycarbonate,
- Bimetal contacts with Silver Tip
- Also available with touch
and remote

POLYCARB

LEVANA

**CAPRINA
SERIES**

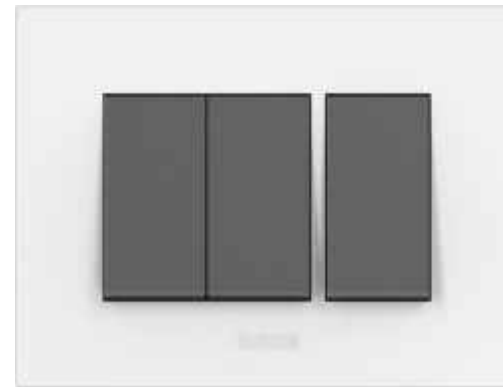

WHITE

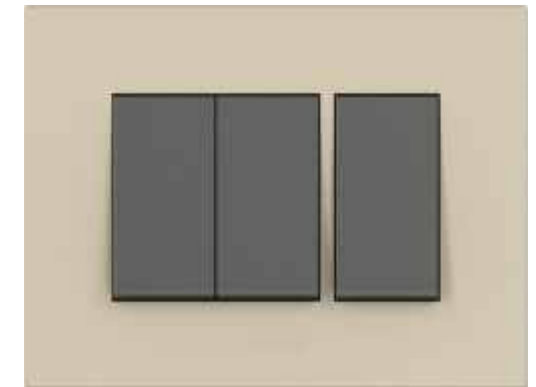

CHAMPAGNE GOLD

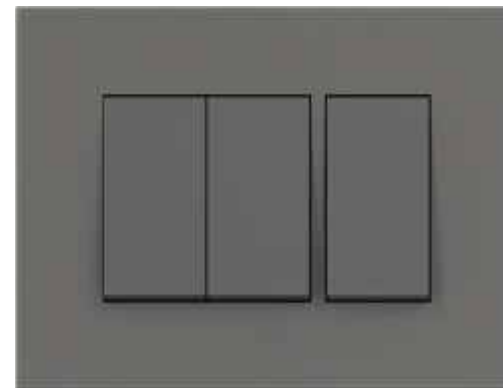

MAGNESIUM GREY

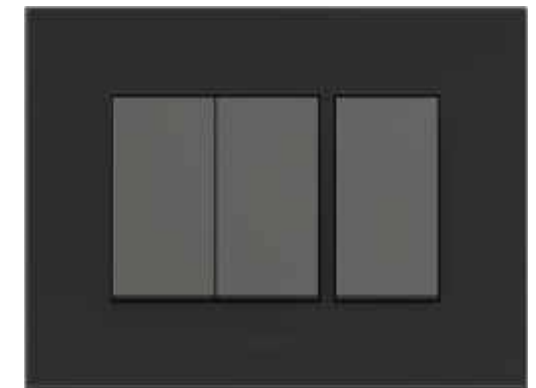

BLACK

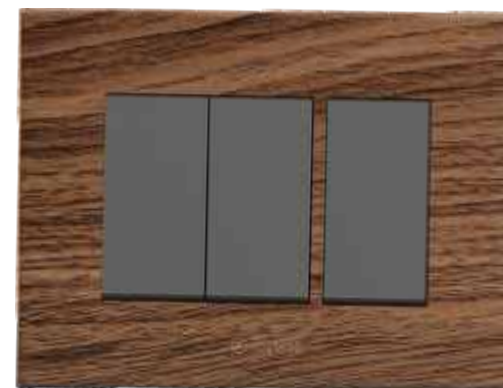

NATURAL WOOD



AFRICAN WENGE

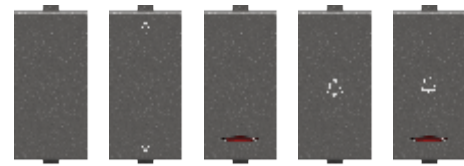

Code	Item Description	Module	MRP/UNIT ₹		Pkg.
			White	Mag. Grey	
10A / 16A SWITCHES					
SLV0100601/02	10A 1-way Switch	1M	105/-	117/-	20/400
SLV0100701/02	10A 2-way Switch	1M	135/-	148/-	20/120
SLV0100801/02	10A 1-way Switch w/ind.	1M	135/-	148/-	20/120
SLV0100901/02	10A Bell Push	1M	136/-	149/-	20/120
SLV0101001/02	10A Bell Push w/ind.	1M	152/-	167/-	20/120
SLV0101101/02	16A 1-way Switch	1M	152/-	167/-	20/200
SLV0101201/02	16A 2-way Switch	1M	197/-	215/-	20/120
SLV0101301/02	16A 1-way Switch w/ind.	1M	197/-	215/-	20/200

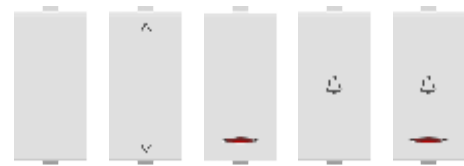

Code	Item Description	Module	MRP/UNIT ₹		Pkg.
			White	Mag. Grey	
10A / 16A SWITCHES PRO					
SLV3100601/02	10A 1-way Switch Pro	1M	105/-	117/-	20/400
SLV3100701/02	10A 2-way Switch Pro	1M	135/-	148/-	20/120
SLV3100801/02	10A 1-way Switch w/Ind. Pro	1M	135/-	148/-	20/120
SLV3100901/02	10A Bell Push Pro	1M	136/-	141/-	20/120
SLV3101001/02	10A Bell Push w/ind. Pro	1M	152/-	167/-	20/120
SLV3101101/02	16A 1-way Switch Pro	1M	152/-	167/-	20/200
SLV3101201/02	16A 2-way Switch Pro	1M	197/-	215/-	20/120
SLV3101301/02	16A 1-way Switch w/ind. Pro	1M	197/-	215/-	20/200



Code	Item Description	Module	MRP/UNIT ₹		Pkg.
			White	Mag. Grey	
10A / 16A SWITCHES					
SLV0101701/02	10A 1-way Switch w/ind.	2M	172/-	190/-	10/100
SLV0102401/02	10A 2-way Switch	2M	172/-	190/-	10/100
SLV0101901/02	10A Bell Push w/ind.	2M	178/-	197/-	10/100
SLV0102001/02	16A 1-way Switch w/ind.	2M	229/-	244/-	10/100
SLV0102301/02	32A DP 1-way Switch w/ind.	2M	310/-	363/-	10/100

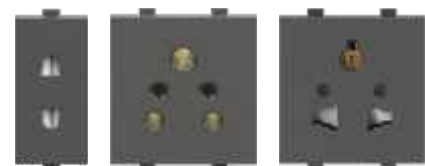

Code	Item Description	Module	MRP/UNIT ₹		Pkg.
			White	Mag. Grey	
SOCKETS					
SLV0200101/02	6A 2-Pin Socket Outlet Euro	1M	104/-	114/-	20/120
SLV0200201/02	6A 5-Pin Socket Outlet	2M	106/-	115/-	10/100
SLV0200301/02	6A Socket Outlet-Multi	2M	149/-	165/-	10/200
SLV0200501/02	6/16A Twin Socket Outlet Shuttered	2M	235/-	255/-	10/100
SLV0200601/02	6/25 A Universal Socket	2M	288/-	316/-	10/100
SLV0200701/02	6/16A Twin Socket Outlet Shuttered (for Glass Plates)	2M	248/-	273/-	10/100

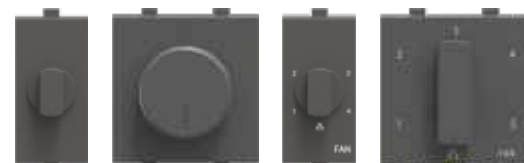

Code	Item Description	Module	MRP/UNIT ₹		Pkg.
			White	Mag. Grey	
DIMMER / FAN REGULATOR					
SLV0300101/02	Dimmer 400w	1M	306/-	322/-	10/100
SLV0300201/02	Dimmer 400w	2M	446/-	476/-	1/100
SLV0300301/02	4-Step 360-deg. Fan Regulator	1M	414/-	455/-	10/100
SLV0300401/02	5-Step 360-deg. Fan Regulator	2M	489/-	536/-	10/100

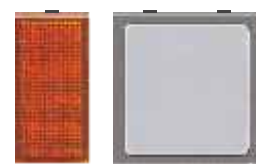

Code	Item Description	Module	MRP/UNIT ₹		Pkg.
			White	Mag. Grey	
NEON INDICATOR / NIGHT LAMP					
SLV0300501	Neon Indicator 230V	1M	126/-		20/120
SLV0300601/02	Night Lamp 230V	2M	347/-	374/-	10/60

Code	Item Description	Module	MRP/UNIT ₹		Pkg.
			White	Mag. Grey	
BUZZER / FOOT-LIGHT / LED WITH SHRINK SLEEVE					
SLV0300701/02	Electronic Buzzer 230V	2M	252/-	272/-	10/60
SLV0300801/02	Foot-light w/3-LED 230V	2M	359/-	394/-	10/60
SLV0300900	L.E.D with Shrink Sleeve		30/-		30/300



Code	Item Description	Module	MRP/UNIT ₹		Pkg.
			White	Mag. Grey	
TELEPHONE SOC. / CAT-5 / CAT-6 / TV SOCKET					
SLV0400101/02	RJ-11 Telephone Socket Shuttered 2L	1M	152/-	167/-	20/120
SLV0400201/02	RJ-11 Telephone Socket 4L	1M	186/-	203/-	20/120
SLV0400401/02	RJ-45 Krone Jack CAT-6 Shuttered	1M	665/-	725/-	10/100
SLV0400501/02	TV Co-axial Socket	1M	142/-	156/-	20/120



Code	Item Description	Module	MRP/UNIT ₹		Pkg.
			White	Mag. Grey	
DND TOUCH PANEL (INDOOR & OUTDOOR) / ELECTRONIC SWITCH					
SLV0500101/02	Do Not Disturb Indicator Unit (Outside)	1M	138/-	138/-	20/120
SLV0500701/02	Make My Room Indicator Unit (Outside)	1M	138/-	138/-	20/120
SLV0500801/02	Pick My Laundry Indicator Unit (Outside)	1M	138/-	138/-	20/120
SLV0500201/02	Do Not Disturb Switch With LED (Inside)	1M	149/-	162/-	20/120
SLV0500901/02	Make My Room Switch With LED (Inside)	1M	149/-	162/-	20/120
SLV0501001/02	Pick My Laundry Switch With LED (Inside)	1M	149/-	162/-	20/120
SLV0500501/02	25 A Electronic Switch With Card	3M	2231/-	2360/-	5/30
SLV0500601	Electronic Card Only		119/-		



Code	Item Description	Module	MRP/UNIT ₹		Pkg.
			White	Mag. Grey	
BLANK PLATE					
SLV0800101/02	Blank Plate	1M	23/-	30/-	30/300





Code	Item Description	Module	MRP/UNIT ₹ White Mag. Grey	Pkg.
MINI MCBS / MOTOR STARTER SWITCH / USB CHARGER				
SLV0710601/02	6A 1P Mini MCB	1M	296/- 328/-	10/100
SLV0711001/02	10A 1P Mini MCB	1M	296/- 328/-	10/100
SLV0711601/02	16A 1P Mini MCB	1M	296/- 328/-	10/100
SLV0712001/02	20A 1P Mini MCB	1M	296/- 328/-	10/100
SLV0712501/02	25A 1P Mini MCB	1M	296/- 328/-	10/100
SLV0713201/02	32A 1P Mini MCB	1M	296/- 328/-	10/100
SLV0720601/02	6A 1P+N Mini MCB	2M	631/- 695/-	10/60
SLV0721001/02	10A 1P+N Mini MCB	2M	631/- 695/-	10/60
SLV0721601/02	16A 1P+N Mini MCB	2M	631/- 695/-	10/60
SLV0722001/02	20A 1P+N Mini MCB	2M	631/- 695/-	10/60
SLV0722501/02	25A 1P+N Mini MCB	2M	631/- 695/-	10/60
SLV0723201/02	32A 1P+N Mini MCB	2M	631/- 695/-	10/60
SLV1022501/02	25A 1P+N Motor Starter Switch	2M	654/- 714/-	10/60
SLV1023201/02	32A 1P+N Motor Starter Switch	2M	654/- 714/-	10/60
SLV1800201/02	2A USB Charger 2000mA/5V	2M	1301/- 1362/-	10/60
SLV1800401/02	2A USB Charger with Charging indication	1M	1222/- 1344/-	10/100
SLV0400601/02	HDMI Socket	1M	1228/- 1350/-	10/100
SLV04L0601/02	HDMI Socket - L Shape	1M	1228/- 1350/-	10/100
SLV0400701/02	Shaver Socket	2M	1473/- 1620/-	10/60

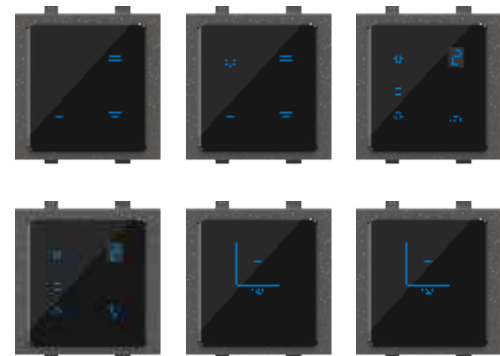

Code	Item Description	Module	MRP/UNIT ₹	Pkg.
IR TOUCH SCREEN SWITCH / FAN REGULATOR & LIGHT DIMMER / 16A / 30A				
SLV1400101/02	4 Switch IR Touch Screen	2M	5005/- 5363/-	5/30
SLV1400201/02	3 Switch 1 Bell IR Touch Screen	2M	5005/- 5363/-	5/30
SLV1400301/02	6 Fan Regulator IT 8 Step Touch Screen	2M	5482/- 5840/-	5/30
SLV1400401/02	Light Dimmer IR 9 Step 300W Touch Screen	2M	5482/- 5840/-	5/30
SLV1400501/02	16A Switch w/ind. IR Touch Screen	2M	4171/- 4409/-	5/30
SLV1400601/02	30A Switch w/ind. IR Touch Screen	2M	4171/- 4409/-	5/30



Code	Item Description	Module	MRP/UNIT ₹	Pkg.
IR TOUCH SCREEN - DND / CLEAN MY ROOM / BELL SWITCH / REMOTE CONTROL				
SLV1400701/02	DND / Clean My Room Indicator with Bell IR Touch Screen Outdoor	2M	4171/- 4409/-	5/30
SLV1400801/02	DND / Clean My Room IR Touch Screen Indoor Unit	2M	4171/- 4409/-	5/30
SLV1400901/02	Bell Switch IR Touch Screen	2M	3575/- 3814/-	5/30
SLV1401000	Remote Control Unit Touch Pad		1907/-	5/30



Code	Item Description	Module	MRP/UNIT ₹ Mag. Grey	Pkg.
1/2/3/4/ SWITCH AND 2 SWITCH 1 BELL TOUCH FEEL				
SLV1600102	1 Switch IR Touch Feel	2M	3551/-	5/30
SLV1600202	2 Switch IR Touch Feel	2M	4171/-	5/30
SLV1600302	4 Switch IR Touch Feel	2M	5363/-	5/30
SLV1600402	3 Switch 1 Bell IR Touch Feel	2M	5363/-	5/30



Code	Item Description	Module	MRP/UNIT ₹	Pkg.
FAN REGULATOR / LIGHT DIMMER TOUCH FEEL				
SLV1600502	Fan Regulator 8 Step IR Touch Feel	2M	5840/-	5/30
SLV1600602	Light Dimmer 9 Step 300W IR Touch Feel	2M	5840/-	5/30
SLV1600702	16A Switch w/ind. IR Touch Feel	2M	4409/-	5/30
SLV1600802	30A Switch w/ind. IR Touch Feel	2M	4409/-	5/30
SLV1600902	Bell Switch IR Touch Feel	2M	3814/-	5/30



Code	Item Description	Module	MRP/UNIT ₹	Pkg.
KIDZZ SWITCHES (for KIDS)				
SLV16G1005	Kids Smiley Switches (Pink-Girl) 40 IR Switch + 2M Plate	2M	6999/-	1/5
SLV16G1006	Kids Smiley Switches (Blue-Boy) 4 IR Switch + 2M Plate	2M	6999/-	1/5
SLV1601005	Smiley 4 IR Touch Switches - Pink	2M	6879/-	5/30
SLV1601006	Smiley 4 IR Touch Switches - Blue	2M	6879/-	5/30



CHILD SAFETY



VALENCIA SERIES

GLASS COVER PLATES (Available Colours)



GLASS PLATES - COLOURS

MODULES	1M CODE	2M CODE	3M CODE	4M CODE	6M CODE	8M (H.) CODE	8M (Sq.) CODE	12M CODE	18M CODE
WHITE	SLV1100101	SLV1100201	SLV1100301	SLV1100401	SLV1100601	SLV1100801	SLV11S0801	SLV1101201	SLV1101801
SILVER	SLV1100103	SLV1100203	SLV1100303	SLV1100403	SLV1100603	SLV1100803	SLV11S0803	SLV1101203	SLV1101803
BLACK	SLV1100104	SLV1100204	SLV1100304	SLV1100404	SLV1100604	SLV1100804	SLV11S0804	SLV1101204	SLV1101804
RED	SLV1100105	SLV1100205	SLV1100305	SLV1100405	SLV1100605	SLV1100805	SLV11S0805	SLV1101205	SLV1101805
CHOCOLATE	SLV1100114	SLV1100214	SLV1100314	SLV1100414	SLV1100614	SLV1100814	SLV11S0814	SLV1101214	SLV1101814
M.R.P. ₹	595/-	595/-	775/-	952/-	1191/-	1519/-	1359/-	1906/-	2294/-

GLASS PLATES - BEVELLED EDGE / FROSTED MIRROR

MODULES	1M	2M	3M	4M	6M	8M (H.)	8M (Sq.)	12M	18M
CODE	SLV1200113	SLV1200213	SLV1200313	SLV1200413	SLV1200613	SLV1200813	SLV12S0813	SLV1201213	SLV1201813
M.R.P. ₹	833/-	833/-	1107/-	1360/-	1701/-	2170/-	1941/-	2722/-	3277/-

GLASS PLATES - BRONZE MIRROR

MODULES	1M	2M	3M	4M	6M	8M (H.)	8M (Sq.)	12M	18M
CODE	SLV1200112	SLV1200212	SLV1200312	SLV1200412	SLV1200612	SLV1200812	SLV12S0812	SLV1201212	SLV1201812
M.R.P. ₹	833/-	833/-	1107/-	1360/-	1701/-	2170/-	1941/-	2722/-	3277/-

CRYSTAL PLATES - COLOURS

MODULES	1M	2M	3M CODE	4M	6M CODE	8M (H.)	8M (Sq.)	12M	18M
WHITE			SLV1100301		SLV2100601				
GREY			SLV1100303		SLV2100602				
M.R.P. ₹			7000/-		13000/-				
Glass Plates Pkg.	5 / 60	5 / 60	5 / 60	5 / 40	5 / 30	5 / 20	5 / 20	5 / 20	5 / 15

GLASS PLATES - SUPPORT FRAME

MODULES	1M	2M	3M	4M	6M	8M (H.)	8M (Sq.)	12M	18M
CODE	SLV1300200	SLV1300200	SLV1300300	SLV1200400	SLV1200600	SLV1200800	SLV12S0800	SLV1201200	SLV1201800
M.R.P. ₹	58/-	58/-	70/-	79/-	201/-	244/-	244/-	332/-	447/-
Support Plates Pkg.	10 / 100	10 / 100	10 / 100	10 / 100	5 / 50	5 / 50	5 / 50	5 / 50	5 / 25

COVER PLATES (Available Colours)

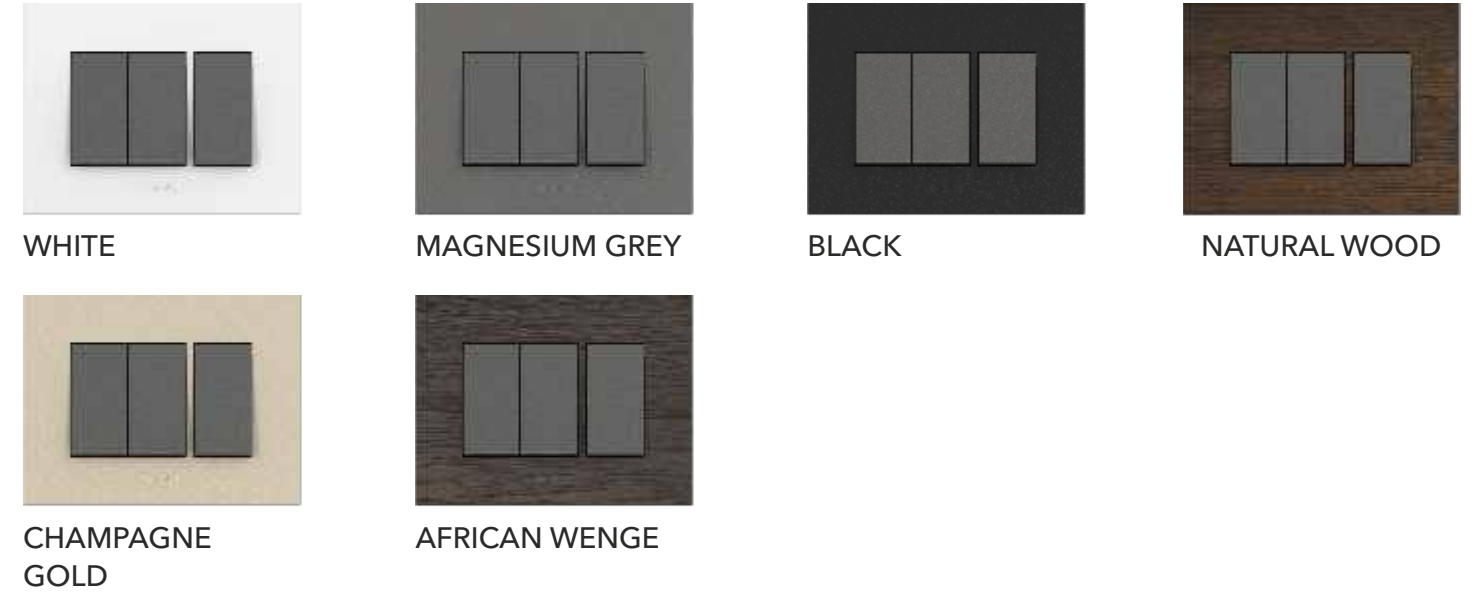

CAPRINA SERIES

GLOSSY WHITE WITH BLACK BASE

MODULES	1M	2M	3M	4M	6M	8M (H.)	8M (Sq.)	12M	16M	18M
CODE	SLV0900101	SLV0900201	SLV0900301	SLV0900401	SLV0900601	SLV0900801	SLV09S0801	SLV0901201	SLV0901601	SLV0901813
M.R.P. ₹	96/-	96/-	117/-	140/-	191/-	244/-	244/-	289/-	318/-	351/-

GLOSSY WHITE WITH WHITE BASE

MODULES	1M	2M	3M	4M	6M	8M (H.)	8M (Sq.)	12M	16M	18M
CODE	SLV0900112	SLV0900212	SLV0900312	SLV0900412	SLV0900612	SLV0900812	SLV09S0812	SLV0901212	SLV0901612	SLV0901812
M.R.P. ₹	96/-	96/-	117/-	140/-	191/-	244/-	244/-	289/-	318/-	351/-

COLOURS

MODULES	1M CODE	2M CODE	3M CODE	4M CODE	6M CODE	8M (H.) CODE	8M (Sq.) CODE	12M CODE	16M CODE	18M CODE
MAG. GREY	SLV0900102	SLV0900202	SLV0900302	SLV0900402	SLV0900602	SLV0900802	SLV09S0802	SLV0901202	SLV0901602	SLV0901802
BLACK	SLV0900106	SLV0900206	SLV0900306	SLV0900406	SLV0900606	SLV0900806	SLV09S0806	SLV0901206	SLV0901606	SLV0901806
CHAMP. GOLD	SLV0900107	SLV0900207	SLV0900307	SLV0900407	SLV0900607	SLV0900807	SLV09S0807	SLV0901207	SLV0901607	SLV0901807
M.R.P. ₹	147/-	147/-	191/-	215/-	276/-	369/-	369/-	460/-	490/-	520/-

WOODEN FINISH

MODULES	1M CODE	2M CODE	3M CODE	4M CODE	6M CODE	8M (H.) CODE	8M (Sq.) CODE	12M CODE	16M CODE	18M CODE
AFRICAN WENGE	SLV0900108	SLV0900208	SLV0900308	SLV0900408	SLV0900608	SLV0900808	SLV09S0808	SLV0901208	SLV0901608	SLV0901808
NATURAL WOOD	SLV0900110	SLV0900210	SLV0900310	SLV0900410	SLV0900610	SLV0900810	SLV09S0810	SLV0901210	SLV0901610	SLV0901810
M.R.P. ₹	183/-	183/-	244/-	295/-	398/-	520/-	520/-	643/-	674/-	706/-
Pkg.	10 / 100	10 / 100	10 / 100	10 / 100	5 / 50	5 / 50	5 / 50	5 / 50	5 / 25	5 / 25

ACACIA SERIES

COVER PLATES (Available Colours)



WHITE

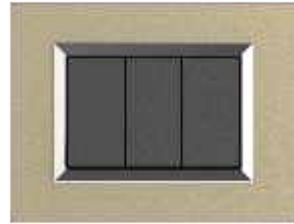

CHAMPAGNE GOLD

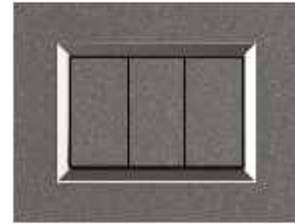

MAGNESIUM GREY

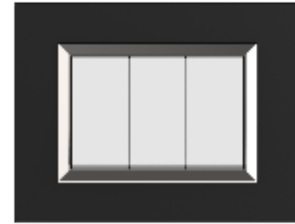

MATT BLACK



GREY GRANITE



CAROLINA OAK



MOSS GREEN

ACACIA PLATE - WHITE

MODULES	1M	2M	3M	4M	6M	8M (H.)	8M (Sq.)	12M	18M
CODE	SLV1500101	SLV1500201	SLV1500301	SLV1500401	SLV1500601	SLV1500801	SLV1550801	SLV1501201	SLV1501801
M.R.P. ₹	155/-	155/-	195/-	225/-	315/-	395/-	395/-	545/-	725/-
Pkg.	10 / 100	10 / 100	10 / 100	10 / 100	5 / 50	5 / 50	5 / 50	5 / 50	5 / 25

ACACIA PLATE - COLOUR

MODULES	1M CODE	2M CODE	3M CODE	4M CODE	6M CODE	8M (H.) CODE	8M (Sq.) CODE	12M CODE	18M CODE
MAG. GREY	SLV1500102	SLV1500202	SLV1500302	SLV1500402	SLV1500602	SLV1500802	SLV1550802	SLV1501202	SLV1501802
MATT BLACK	SLV1500103	SLV1500203	SLV1500303	SLV1500403	SLV1500603	SLV1500803	SLV1550803	SLV1501203	SLV1501803
CHAMP. GOLD	SLV1500104	SLV1500204	SLV1500304	SLV1500404	SLV1500604	SLV1500804	SLV1550804	SLV1501204	SLV1501804
MOSS GREEN	SLV1500105	SLV1500205	SLV1500305	SLV1500405	SLV1500605	SLV1500805	SLV1550805	SLV1501205	SLV1501805
M.R.P. ₹	190/-	190/-	230/-	275/-	400/-	475/-	475/-	675/-	870/-
Glass Plates Pkg.	10 / 100	10 / 100	10 / 100	10 / 100	5 / 50	5 / 50	5 / 50	5 / 50	5 / 25

ACACIA PLATE - MARBLE / WOODEN FINISH

MODULES	1M CODE	2M CODE	3M CODE	4M CODE	6M CODE	8M (H.) CODE	8M (Sq.) CODE	12M CODE	18M CODE
GREY GRANITE	SLV1500106	SLV1500206	SLV1500306	SLV1500406	SLV1500606	SLV1500806	SLV1550806	SLV1501206	SLV1501806
CAROLINA OAK	SLV1500107	SLV1500207	SLV1500307	SLV1500407	SLV1500607	SLV1500807	SLV1550807	SLV1501207	SLV1501807
M.R.P. ₹	250/-	250/-	320/-	380/-	510/-	630/-	630/-	880/-	1200/-
Glass Plates Pkg.	10 / 100	10 / 100	10 / 100	10 / 100	5 / 50	5 / 50	5 / 50	5 / 50	5 / 25

COVER PLATES (Available Colours)



WHITE



DARK OAK



MAGNESIUM GREY



MATT BLACK

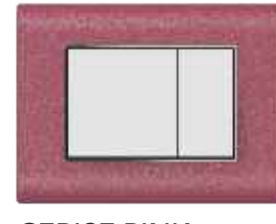

CERISE PINK



DANUBE BLUE

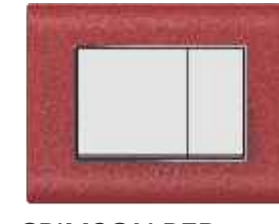

CRIMSON RED

CURL PLUS - WHITE

MODULES	1M	2M	3M	3M / PARTITION	4M	6M	8M (H.)	8M (Sq.)	12M	18M
CODE	SLV3200101	SLV3200201	SLV3200201	SLV32P0301	SLV3200401	SLV3200601	SLV3200801	SLV32S0801	SLV3201201	SLV3201801
M.R.P. ₹	110/-	110/-	130/-	130/-	155/-	230/-	280/-	280/-	375/-	450/-
Pkg.	10 / 100	10 / 100	10 / 100	10 / 100	10 / 100	5 / 50	5 / 50	5 / 50	5 / 50	5 / 25

CURL PLUS - COLOUR

MODULES	1M CODE	2M CODE	3M CODE	3M / PARTITION CODE	4M CODE	6M CODE	8M (H.) CODE	8M (Sq.) CODE	12M CODE	18M CODE
MAG. GREY	SLV3200102	SLV3200202	SLV3200302	SLV32P0302	SLV3200402	SLV3200602	SLV3200802	SLV32S0802	SLV3201202	SLV3201802
CHAMP. GOLD	SLV3200103	SLV3200203	SLV3200303	SLV32P0303	SLV3200403	SLV3200603	SLV3200803	SLV32S0803	SLV3201203	SLV3201803
MATT BLACK	SLV3200104	SLV3200204	SLV3200304	SLV32P0304	SLV3200404	SLV3200604	SLV3200804	SLV32S0804	SLV3201204	SLV3201804
CERISE PINK	SLV3200105	SLV3200205	SLV3200305	SLV32P0305	SLV3200405	SLV3200605	SLV3200805	SLV32S0805	SLV3201205	SLV3201805
CRIMSON RED	SLV3200106	SLV3200206	SLV3200306	SLV32P0306	SLV3200406	SLV3200606	SLV3200806	SLV32S0806	SLV3201206	SLV3201806
DANUBE BLUE	SLV3200108	SLV3200208	SLV3200308	SLV32P0308	SLV3200408	SLV3200608	SLV3200808	SLV32S0808	SLV3201208	SLV3201808
M.R.P. ₹	160/-	160/-	210/-	210/-	225/-	325/-	385/-	385/-	490/-	575/-
Pkg.	10 / 100	10 / 100	10 / 100	10 / 100	10 / 100	5 / 50	5 / 50	5 / 50	5 / 50	5 / 25

CURL PLUS - WOODEN FINISH

MODULES	1M CODE	2M CODE	3M CODE	3M / PARTITION CODE	4M CODE	6M CODE	8M (H.) CODE	8M (Sq.) CODE	12M CODE	18M CODE
DARK OAK	SLV3200107	SLV3200207	SLV3200307	SLV32P0307	SLV3200407	SLV3200607	SLV3200807	SLV32S0807	SLV3201207	SLV3201807
M.R.P. ₹	190/-	190/-	250/-	250/-	310/-	410/-	500/-	500/-	680/-	850/-
Pkg.	10 / 100	10 / 100	10 / 100	10 / 100	10 / 100	5 / 50	5 / 50	5 / 50	5 / 50	5 / 25

CURL
SERIES

COVER PLATES (Available Colours)



WHITE



MAGNESIUM GREY

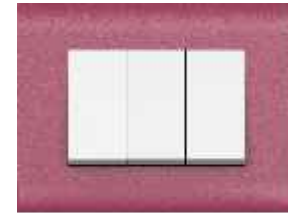

PINK

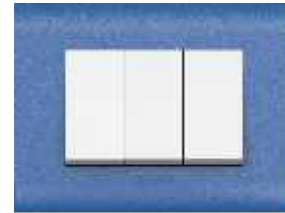

BLUE

CURL - WHITE

MODULES	1M	2M	3M	3M / PARTITION	4M	6M	8M (H.)	8M (Sq.)	12M	18M
CODE	SLV0900113	SLV0900213	SLV0900313	SLV09P0313	SLV0900413	SLV0900613	SLV0900813	SLV09P0813	SLV0901213	SLV0901813
M.R.P. ₹	96/-	96/-	117/-	117/-	140/-	191/-	244/-	244/-	289/-	351/-

CURL - COLOUR

MODULES	1M CODE	2M CODE	3M CODE	3M / PARTITION CODE	4M CODE	6M CODE	8M (H.) CODE	8M (Sq.) CODE	12M CODE	18M CODE
MAG. GREY	SLV3109102	SLV3109202	SLV3109302	SLV31P9302	SLV3109402	SLV3109602	SLV3109802	SLV31P9802	SLV3109122	SLV3109182
PINK	SLV3109103	SLV3109203	SLV3109303	SLV31P9303	SLV3109403	SLV3109603	SLV3109803	SLV31P9803	SLV3109123	SLV3109183
BLUE	SLV3109104	SLV3109204	SLV3109304	SLV31P9304	SLV3109404	SLV3109604	SLV3109804	SLV31P9804	SLV3109124	SLV3109184
M.R.P. ₹	147/-	147/-	191/-	191/-	215/-	313/-	369/-	369/-	460/-	520/-
Pkg.	10 / 100	10 / 100	10 / 100	10 / 100	10 / 100	5 / 50	5 / 50	5 / 50	5 / 50	5 / 25

CONCEALED AND
SURFACE BOX

SURFACE MOUNTING PLASTIC BOX

SPB0200057	1M & 2M Surface mounting Plastic Box	57/-	10/160
SPB0200058	3M Surface mounting Plastic Box	70/-	10/160
SPB0200059	4M Surface mounting Plastic Box	80/-	10/160
SPB0200060	6M Surface mounting Plastic Box	104/-	10/120
SPB0200100	8M Sq. Surface mounting Plastic Box	145/-	5/80
SPB0200062	8M Hor. Surface mounting Plastic Box	145/-	5/80
SPB0200101	12M Surface mounting Plastic Box	186/-	5/60
SPB0200064	18M Surface mounting Plastic Box	242/-	5/60



MODULAR PLATE
with Glowing LED



Glowing LED Switch

Brighten your spaces with these glow-in-the-dark switches.

The plates of these switches are designed with the provision of L.E.D., to glow like recessed downlights and create soothing ambience, additionally helping you locate switch boards in dark.

These L.E.D.s can also be connected to our Dusk/Dawn sensors so they glow automatically in the dark, and turn off automatically in bright light.



Sr. No	Item Code	Description	Pkg.	Mrp(in Rs.)
1	SAC0700001G	6A 4 + 1 MULTI PLUG	30	350/-
2	SAC0700002G	6A 2 PIN G-SQUARE FLEX BOX WITH 4 METER	24	450/-
3	SAC0700003G	6A 2 PIN Power Strip WITH TWIN USB CHARGING POINT	40	750/-
4	SAC0700004G	6 A 3 PIN 4 + 1 Power Strip	40	650/-
5	SAC0700005G	6A TRAVEL ADAPTOR WITH TWIN USB CHARGING PORT MTL	48	575/-
6	SAC0700006G	6A TRAVEL ADAPTOR WITH TWIN USB CHARGING PORT PC	50	570/-
7	SAC0700007G	6A 3 PIN MULTI PLUG WITH SURGE PROTECTOR	40	220/-
8	SAC0700008G	6A 3 PIN MULTI PLUG	40	73/-



6A 3 PIN MULTI PLUG WITH SURGE PROTECTOR



6A TRAVEL ADAPTOR, TWIN USB CHARGING PORT MTL



6A TRAVEL ADAPTOR, TWIN USB CHARGING PORT PC



6A 3 PIN MULTI PLUG



6A 4 + 1 MULTI PLUG



6A 2 PIN POWER STRIP WITH TWIN USB CHARGING PORT



6A 4 + 1 MULTI PLUG



6A 2 PIN G-SQUARE FLEX BOX WITH 4 METER

Experience Precision with Innovation Accessories



Code	Item Description	MRP ₹ PER UNIT	MRP PER UNIT
SAC0200004	16A 3-PIN PLUG ISI	84/-	20 / 160
SAC0200003	06A 3-PIN PLUG ISI	55/-	20 / 240
SAC04OR001	4-WAY EXTENSION BOARD WITH SURGE PROTECTION (ORANGE), cord-Length 3 meter	575/-	1 / 10
SAC04OR002	4-WAY EXTENSION BOARD WITH USB SOCKET / SURGE PROTECTION (ORANGE), cord-Length 3 meter	875/-	1 / 10
SLV1900101	ANGLED / BATTEN BULBHOLDER LEVANA	70/-	20 / 400
SLV2000301	JUMBO CEILING ROSE 3T LEVANA	42/-	20 / 400
SLV2000201	JUMBO CEILING ROSE 2T LEVANA	35/-	20 / 400



4-WAY EXTENSION BOARD



3PIN PLUG TOP



ANGLED / BATTEN BULB HOLDER



JUMBO CEILING ROSE

COVER PLATES WITH MOUNTING PLATES

COVER PLATES (Available Sizes, Dimension is in MM)

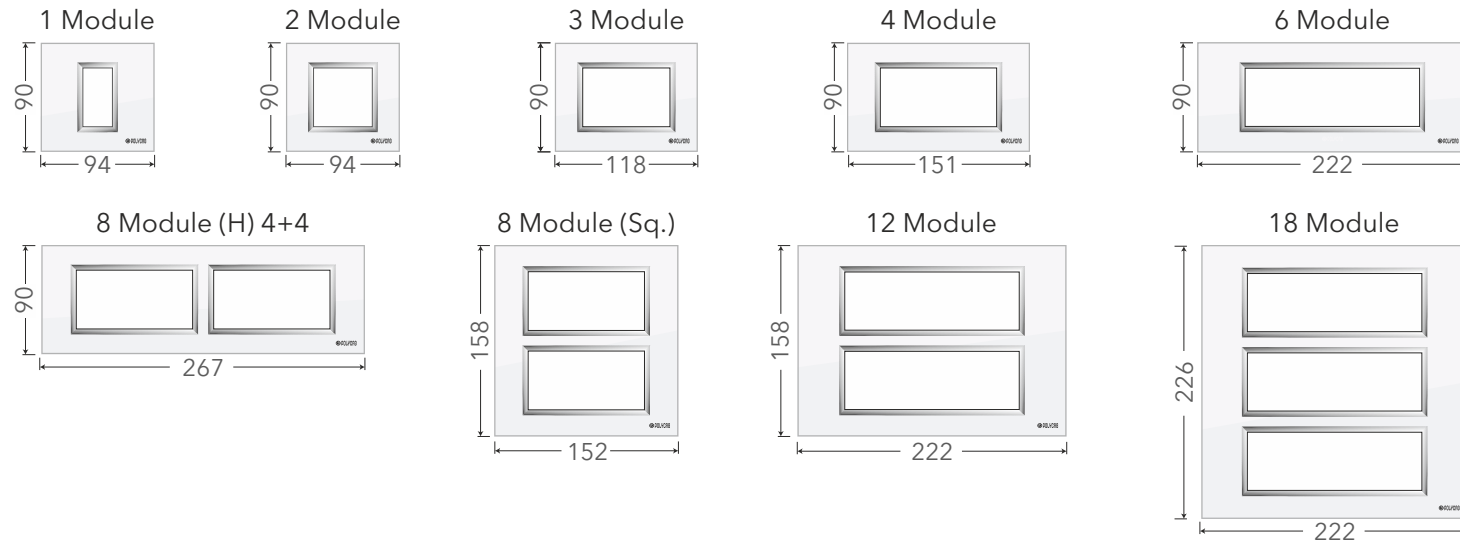

COVER PLATES WITH MOUNTING PLATES (Available Sizes, Dimension is in MM)

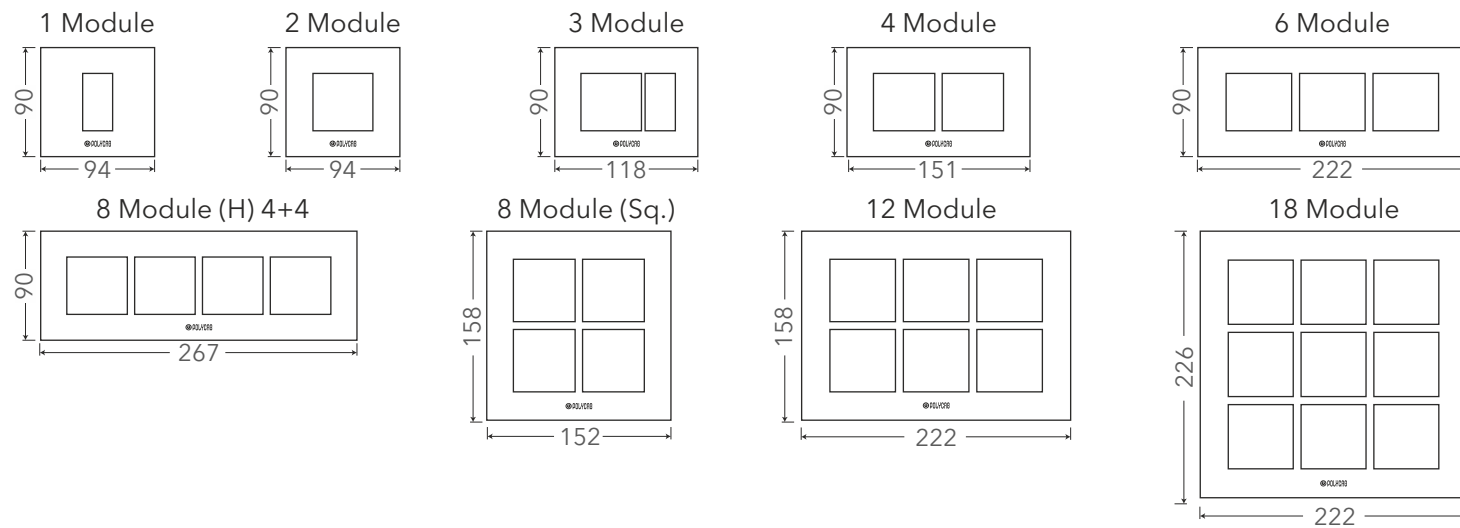

CAPRINA SERIES

SUPPORT FRAMES HORIZONTAL & VERTICAL FOR FIXING (Dimension is in MM)

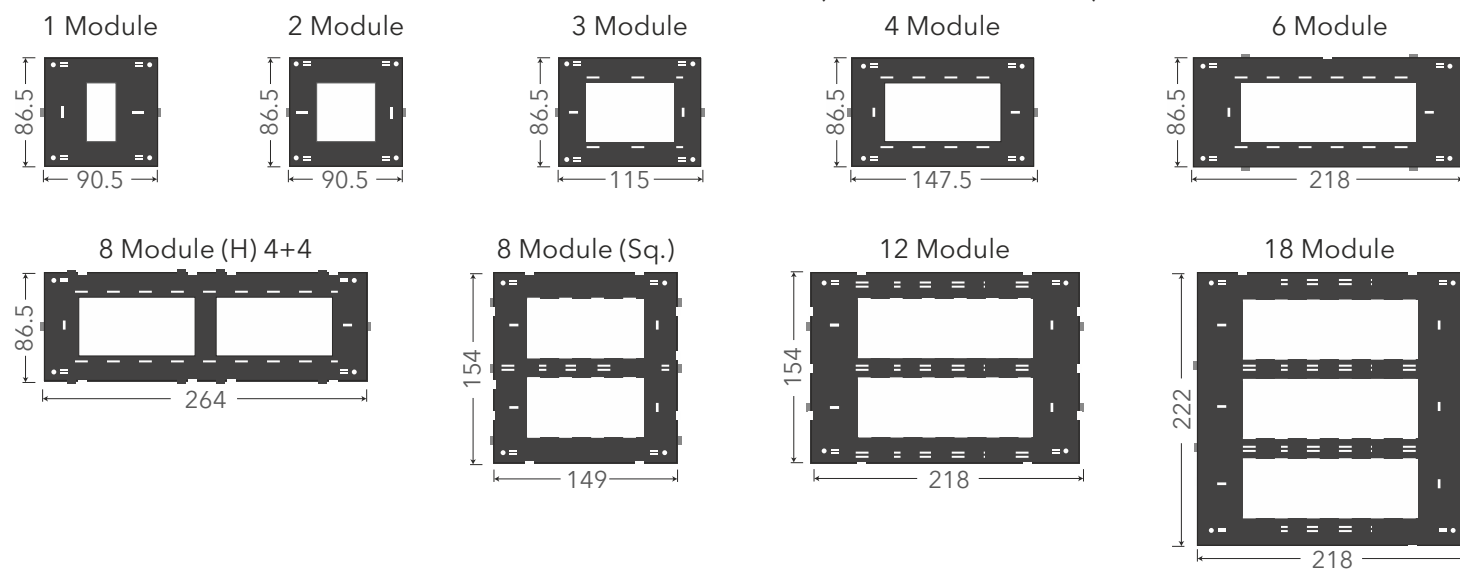

WARRANTY POLICY

LEVANA Switches & Socket	120 Months
Electronic wiring product (viz Dimmers, Step Fan Regulators, Moter Starters, Indicator, Buzzers RJ45, RJ11 & TV sockets)	24 Months
Automation and Accessories	12 Months

Polycab's Products carry a warranty against manufacturing defects, subject to use of the Product for the right application with correct wiring/connection and normal operating conditions.

Email: customer@polycab.com

Toll Free No. : 1800 267 0008

• Working Days: Monday to Saturday • Timings: 9:00 AM to 6:00 PM

Terms and Conditions:

- The prices are inclusive of all Government levies.
- Goods are despatched by us on purchaser's risk.
- All claims for loss, damage or shortage will be filled by the purchaser directly with carriers.
- Disputes, if any are subject to Mumbai jurisdiction only.
- Price are subject to change without notice.
- MRP mentioned is for per unit & in Indian Rupees.
- Due to continuous technology upgrades the design & specifications may vary without notice.